

58258

Installation Instructions

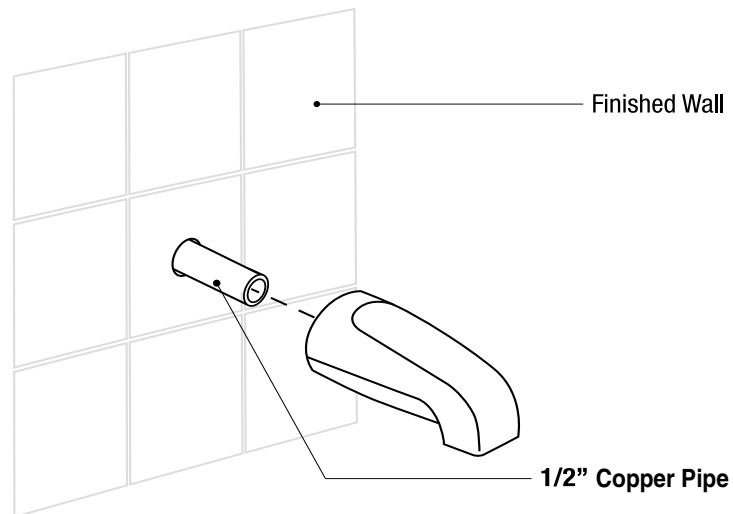

INSTALLATION

1. Loosen the set screw on the underside of the old spout near the wall.
2. Remove old spout by carefully pulling it away from the wall.
3. Loosen the set screw on the new spout.
4. Slip the new spout onto the exposed 1/2" copper pipe and tighten the set screw.