

58481

Installation Instructions

1. Remove bath shoe using a bath shoe removal tool.
Remove worn Bath Shoe Gasket.
2. Using a soft cloth, remove debris from inside drain threads and the lip of the tub.
3. Install new Bath Shoe Gasket between the drain and the tub.
4. Apply plumber's putty under the lip of the existing bath shoe.
5. Reinstall bath shoe and tighten with bath shoe wrench until plumber's putty forms a seal.

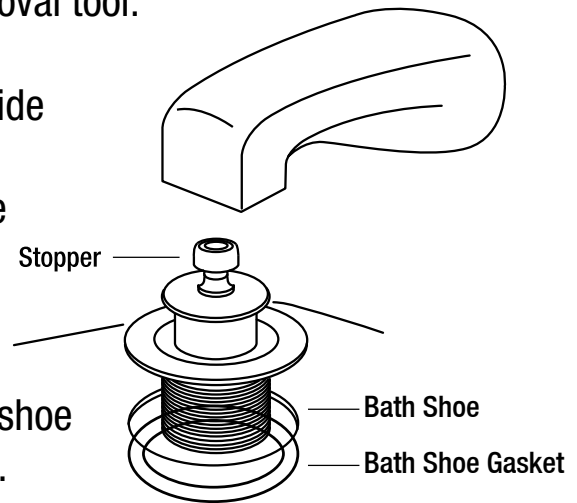

Tools needed for installation:

- Bath Shoe Wrench
- Plumber's Putty