

58508

Installation Instructions

1. Remove Overflow Plate Screws.
2. Carefully remove Overflow Plate and entire linkage assembly.
3. Install Overflow Plate Adapter using two screws from the old plate.
4. Align screw hole on new Overflow Plate and thread screw into place. Tighten with screwdriver.
5. Remove Bath Shoe using a bath shoe removal tool. Remove worn Tub Gasket.
6. Using a soft cloth, remove debris from inside drain threads and the lip of the tub.
7. For 1-3/8" drains, remove plastic bushing/adapter from new Bath Shoe threads and apply pipe thread sealant onto metal outside threads of new Bath Shoe.
For 1-1/2" drains, keep plastic bushing/adapter on the new Bath Shoe threads.
8. Install new Tub Gasket between the drain and the tub.
9. Apply plumber's putty under the lip of the new Bath Shoe.
10. Unscrew Lift & Turn Stopper from new Bath Shoe. Install new Bath Shoe and tighten with bath shoe wrench until plumber's putty forms a seal.
11. With Lift & Turn Stopper in the open position, thread stopper into the new Bath Shoe.

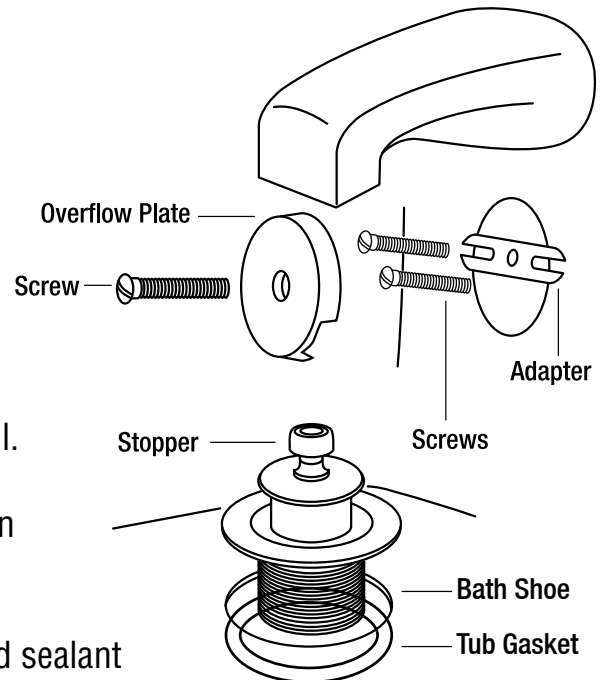

Tools needed for Installation:

Screwdriver • Bath Shoe Wrench • Pipe Thread Sealant • Plumber's Putty